

## Monteringsteknik till industri och karosseri Tillägg

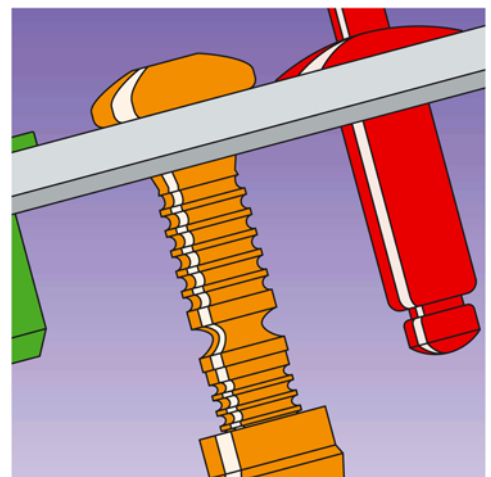
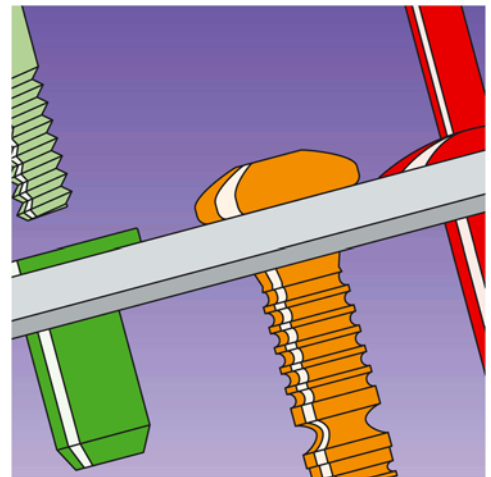
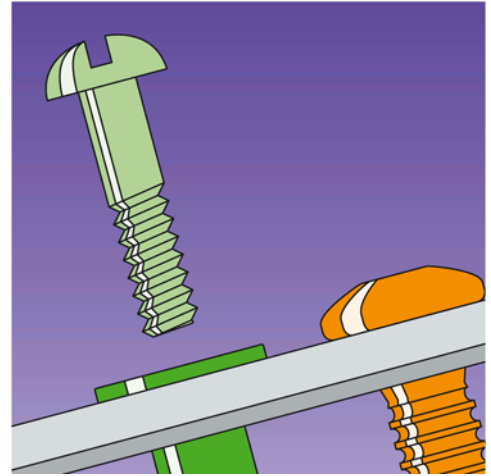

### Innehåll

Monteringsteknik	Blindnitar	<b>Multigrip</b> blindnitar
		Aluminium / Stål ..... 11-01
		Stål / Stål ..... 11-02
		Aluminium / Rostfritt stål (A2) ..... 11-02
		Rostfritt stål (A2/A2) ..... 11-03
		<b>Standard</b> blindnitar
		Aluminium / Stål ..... 11-04
		Stål / Stål ..... 11-07
		Rostfritt stål (A2/A2) ..... 11-08
		Rostfritt stål (A4/A4) ..... 11-09
		<b>Standard</b> blindnitar, färgad
		Aluminium / Stål ..... 11-10
		<b>Räfflad</b> blindnitar
		Aluminium / Stål ..... 11-11
		<b>Split</b> blindnitar
		Aluminium / Stål ..... 11-12
		<b>Trycktäta</b> blindnitar
		Aluminium / Stål ..... 11-14

### Innehåll

075 002 .....	11-01	075 546 .....	11-05	076 562 .....	11-03
075 005 .....	11-01	075 550 .....	11-06		
075 005 .....	11-01	075 552 .....	11-06	076 616 .....	11-09
075 006 .....	11-01	075 555 .....	11-06	076 617 .....	11-09
075 006 .....	11-01	075 574 .....	11-05	076 618 .....	11-09
075 010 .....	11-01	075 575 .....	11-05	076 619 .....	11-09
075 010 .....	11-01	075 576 .....	11-05	076 631 .....	11-09
075 011 .....	11-01			076 632 .....	11-09
075 011 .....	11-01	075 600 .....	11-11	076 633 .....	11-09
075 012 .....	11-01	075 601 .....	11-11	076 634 .....	11-09
075 013 .....	11-01	075 602 .....	11-11	076 636 .....	11-09
075 014 .....	11-01	075 607 .....	11-12	076 646 .....	11-09
075 020 .....	11-01	075 608 .....	11-12	076 647 .....	11-09
075 035 .....	11-02	075 609 .....	11-12	076 648 .....	11-09
075 037 .....	11-02	075 610 .....	11-12	076 649 .....	11-09
075 040 .....	11-02	075 611 .....	11-12	076 650 .....	11-09
075 045 .....	11-02	075 633 .....	11-12	076 651 .....	11-09
075 070 .....	11-02	075 635 .....	11-12	076 652 .....	11-09
075 081 .....	11-02			076 653 .....	11-09
		075 740 .....	11-14	076 662 .....	11-09
075 163 .....	11-04	075 741 .....	11-14	076 663 .....	11-09
075 181 .....	11-04	075 742 .....	11-14	076 664 .....	11-09
075 183 .....	11-04	075 743 .....	11-14	076 665 .....	11-09
075 184 .....	11-04	075 744 .....	11-14	076 666 .....	11-09
075 185 .....	11-04	075 745 .....	11-14	076 667 .....	11-09
075 188 .....	11-04	075 753 .....	11-14	076 668 .....	11-09
		075 755 .....	11-14	076 677 .....	11-09
075 231 .....	11-04			076 678 .....	11-09
075 234 .....	11-04	075 803 .....	11-15	076 679 .....	11-09
075 235 .....	11-04			076 681 .....	11-09
075 236 .....	11-04	076 051 .....	11-07	076 692 .....	11-09
075 254 .....	11-04	076 066 .....	11-07	076 694 .....	11-09
075 255 .....	11-04	076 068 .....	11-07	076 696 .....	11-09
075 256 .....	11-04	076 081 .....	11-07	076 698 .....	11-09
075 257 .....	11-04			076 699 .....	11-09
075 258 .....	11-04	076 102 .....	11-07		
075 259 .....	11-04			076 709 .....	11-09
075 280 .....	11-04	076 505 .....	11-08	076 711 .....	11-09
075 281 .....	11-04	076 506 .....	11-08	076 713 .....	11-09
075 289 .....	11-04	076 507 .....	11-08	076 714 .....	11-09
075 292 .....	11-04	076 509 .....	11-08	076 716 .....	11-09
		076 521 .....	11-08		
075 309 .....	11-04	076 521 .....	11-08		
075 310 .....	11-04	076 522 .....	11-08		
075 314 .....	11-04	076 523 .....	11-08		
075 318 .....	11-04	076 532 .....	11-08		
075 320 .....	11-10	076 533 .....	11-08		
075 340 .....	11-10	076 535 .....	11-08		
		076 540 .....	11-03		
075 501 .....	11-05	076 542 .....	11-03		
075 533 .....	11-05	076 551 .....	11-03		
075 535 .....	11-05	076 552 .....	11-03		
075 540 .....	11-05	076 554 .....	11-03		
075 545 .....	11-05	076 560 .....	11-03		

**TITGEMEYER** <sup>GTO</sup>

**YOUR SOLUTION**

Kullrigt huvud

**Blindnitkrop**  
Aluminium AlMg 2,5

**Splint**  
Stål förzinkat

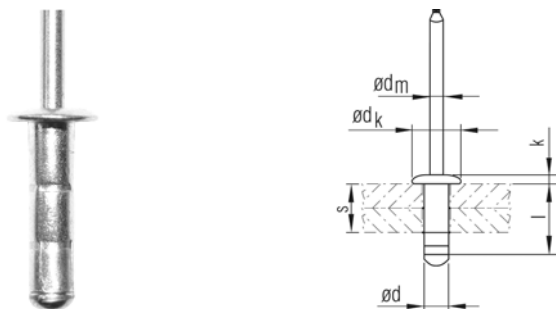

Nominell - $\varnothing$ d [mm]	Borrhål $\varnothing$ [mm]	Klämmområde s [mm]	Blindnit- krop l +1,0/-0,2 [mm]	Huvud		Splint		Brottkraft <sup>1</sup> Nominell		Förpackning		Artikelnr.
				$\varnothing$ $d_k \pm 0,3$ [mm]	Höjd k $\leq$ [mm]	$\varnothing$ $d_m \text{ nom}$ [mm]	Rillad	Skjuvhåll [N]	Drag [N]	Bulk [st]	Box [st]	
3,2	3,3	3,5 - 6,5	9,5	6,6	0,8	1,75	Nej	650	980	10000	1000	075 002
4,0	4,1	1,0 - 6,0	9,5	8,0	1,3	2,15	Nej	850	1200	10000	1000	075 005
		4,0 - 9,0	12,7	8,0	1,3	2,15	Nej	850	1200	10000	1000	075 006
4,8	4,9	1,6 - 6,4	10,3	9,6	1,5	2,63	Nej	1200	1700	10000	500	075 010
		5,0 - 11,0	15,1	9,6	1,5	2,63	Nej	1200	1700	5000	500	075 011
		7,0 - 13,0	17,0	9,6	1,5	2,63	Nej	1200	1700	5000	500	075 012
		7,5 - 14,0	19,0	9,6	1,5	2,63	Nej	1200	1700	5000	500	075 014
		14,8 - 19,8	24,8	9,6	1,5	2,63	Nej	1200	1700	5000	250	075 013

<sup>1</sup> Minsta kraft vid brott

Försänkt huvud 120°

**Blindnitkrop**  
Aluminium AlMg 2,5

**Splint**  
Stål förzinkat

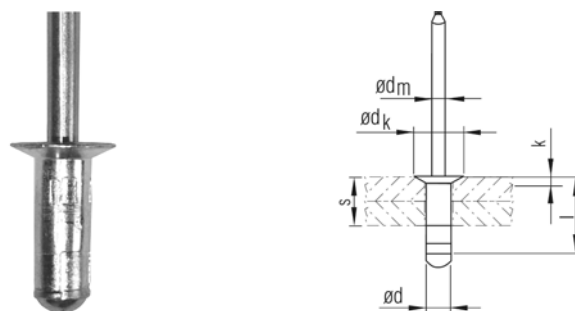

Nominell - $\varnothing$ d [mm]	Borrhål $\varnothing$ [mm]	Klämmområde s [mm]	Blindnit- krop l +1,0/-0,2 [mm]	Huvud		Splint		Brottkraft <sup>1</sup> Nominell		Förpackning		Artikelnr.
				$\varnothing$ $d_k \pm 0,3$ [mm]	Höjd k $\leq$ [mm]	$\varnothing$ $d_m \text{ nom}$ [mm]	Rillad	Skjuvhåll [N]	Drag [N]	Bulk [st]	Box [st]	
3,2	3,3	0,5 - 6,5	9,7	6,0	0,9	1,75	Nej	650	980	10000	1000	075 020

<sup>1</sup> Minsta kraft vid brott

# MULTIGRIP blindnitar

Kullrigt huvud

**Blindnitkrop**  
Stål förzinkat

**Splint**  
Stål förzinkat

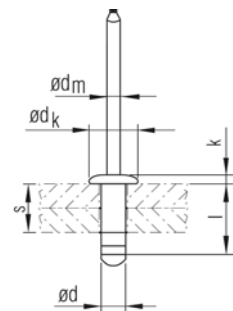

Nominell - $\emptyset$ d [mm]	Borrhål $\emptyset$ [mm]	Klämmområde s [mm]	Blindnit- krop l +1,0/-0,2 [mm]	Huvud		Splint		Brottkraft <sup>1</sup> Nominell		Förpackning		Artikelnr.
				$\emptyset$ d <sub>k</sub> ± 0,3 [mm]	Höjd k ≤ [mm]	$\emptyset$ d <sub>m nom</sub> [mm]	Rillad	Skjuvhåll [N]	Drag [N]	Bulk [st]	Box [st]	
3,2	3,3	1,0 - 4,0	9,0	6,6	0,8	1,75	Nej	830	1180	10000	1000	075 070
4,8	5,0	4,0 - 6,5	12,2	10,0	1,25	2,75	Nej	2050	2940	4000	500	075 081

<sup>1</sup> Minsta kraft vid brott

Kullrigt huvud

**Blindnitkrop**  
Aluminium AlMg 2,5

**Splint**  
Rostfritt stål EN 1.4301 (A2)

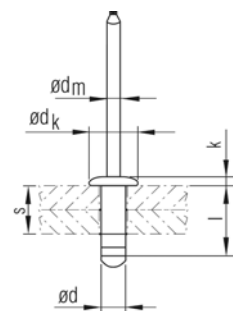

Nominell - $\emptyset$ d [mm]	Borrhål $\emptyset$ [mm]	Klämmområde s [mm]	Blindnit- krop l +1,0/-0,2 [mm]	Huvud		Splint		Brottkraft <sup>1</sup> Nominell		Förpackning		Artikelnr.
				$\emptyset$ d <sub>k</sub> +0,0/-0,5 [mm]	Höjd k ≤ [mm]	$\emptyset$ d <sub>m nom</sub> [mm]	Rillad	Skjuvhåll [N]	Drag [N]	Bulk [st]	Box [st]	
3,2	3,3	1,0 - 5,0	8,0	6,3	1,0	1,75	Nej	500	700	20000	1000	075 035
		3,5 - 8,0	11,1	6,3	1,0	1,75	Nej	500	700	20000	1000	075 037
4,0	4,1	1,5 - 6,0	9,5	8,0	1,3	2,15	Nej	850	1200	10000	1000	075 040
4,8	4,9	1,6 - 6,4	10,3	9,6	1,5	2,63	Nej	1200	1700	5000	500	075 045

<sup>1</sup> Minsta kraft vid brott

Tekniska specifikationer är rådgivande och utan garanti! Rätt till ändringar förbehållas.

Kullrigt huvud

**Blindnitkrop**

Rostfritt stål EN 1.4319 (A2)

**Splint**

Rostfritt stål EN 1.4301 (A2)

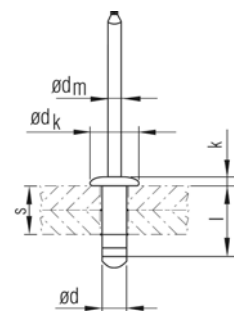

Nominell - $\varnothing$ d [mm]	Borrhål $\varnothing$ [mm]	Klämmområde s [mm]	Blindnit- krop l $+1,0/-0,2$ [mm]	Huvud		Splint		Brottkraft <sup>1</sup> Nominell		Förpackning		Artikelnr.
				$\varnothing$ d <sub>k</sub> $+0,0/-0,6$ [mm]	Höjd k $\leq$ [mm]	$\varnothing$ d <sub>m nom</sub> [mm]	Rillad	Skjuvhåll [N]	Drag [N]	Bulk [st]	Box [st]	
3,2	3,3	1,0 - 5,0	8,0	6,3	0,9	2,15	Ja	1600	1900	10000	1000	<b>076 540</b>
			14,0	6,3	0,9	2,15	Ja	1600	1900	10000	1000	<b>076 542</b>
4,0	4,1	1,5 - 6,0	10,0	8,0	1,3	2,70	Ja	2400	3200	10000	500	<b>076 551</b>
			12,0	8,0	1,3	2,70	Ja	2400	3200	10000	500	<b>076 552</b>
			14,0	8,0	1,3	2,70	Ja	2400	3200	10000	500	<b>076 554</b>
4,8	4,9	1,5 - 6,0	10,0	9,6	1,6	3,18	Ja	4100	4500	5000	500	<b>076 560</b>
			14,0	9,6	1,6	3,18	Ja	4100	4500	5000	500	<b>076 562</b>

<sup>1</sup> Minsta kraft vid brott

# Standard blindnitar

Kullrigt huvud

**Blindnitkrop**  
Aluminium AIMg 3,5

**Splint**  
Stål förzinkat

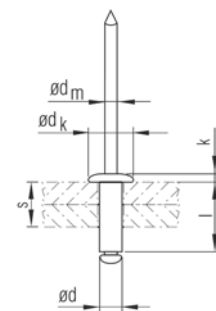

Nominell - ø d [mm]	Borrhål ø [mm]	Klämmområde s [mm]	Blindnit- krop l +1,0/-0,2 [mm]	Huvud		Splint		Brottkraft <sup>1</sup> Nominell		Förpackning		Artikelnr.
				ø d <sub>k</sub> +0,0/-0,4 [mm]	Höjd k ≤ [mm]	ø d <sub>m</sub> nom [mm]	Rillad	Skjuvhåll [N]	Drag [N]	Bulk [st]	Box [st]	
3,0	3,1	3,5 - 5,0	8,0	6,3	1,0	1,70	Nej	500	800	10000	1000	<b>075 163</b>
3,2	3,3	1,5 - 3,5	6,0	6,3	1,0	1,75	Nej	760	980	10000	1000	<b>075 181</b>
		3,5 - 5,0	8,0	6,3	1,0	1,75	Nej	760	980	10000	1000	<b>075 183</b>
		5,0 - 6,5	9,0	6,5	0,8	1,75	Nej	800	1180	5000	1000	<b>075 184</b>
		5,0 - 7,0	10,0	6,3	1,0	1,75	Nej	760	980	10000	1000	<b>075 185</b>
		9,0 - 11,0	14,0	6,3	1,0	1,75	Nej	760	980	10000	1000	<b>075 188</b>
4,0	4,1	3,0 - 5,0	8,0	8,0	1,3	2,15	Nej	1200	1600	10000	1000	<b>075 231</b>
		5,0 - 6,5	10,0	8,0	1,3	2,15	Nej	1200	1600	10000	1000	<b>075 234</b>
		6,5 - 8,5	12,0	8,0	1,3	2,15	Nej	1200	1600	10000	1000	<b>075 235</b>
		8,5 - 10,5	14,0	8,0	1,3	2,15	Nej	1200	1600	5000	500	<b>075 236</b>
4,8	4,9	4,0 - 6,0	10,0	9,5	1,4	2,63	Nej	1690	2230	5000	500	<b>075 254</b>
		5,0 - 7,0	11,0	9,5	1,4	2,63	Nej	1690	2230	5000	500	<b>075 255</b>
		6,0 - 8,0	12,0	9,5	1,4	2,63	Nej	1690	2230	5000	500	<b>075 256</b>
		8,0 - 10,0	14,0	9,5	1,4	2,63	Nej	1690	2230	5000	500	<b>075 257</b>
		10,0 - 12,0	16,0	9,5	1,4	2,63	Nej	1690	2230	5000	500	<b>075 258</b>
5,0	5,1	12,0 - 14,0	18,0	9,5	1,4	2,63	Nej	1690	2230	5000	500	<b>075 259</b>
		1,0 - 3,0	6,0	9,5	1,1	2,75	Nej	2100	2940	-	500	<b>075 280</b>
		2,0 - 4,5	8,0	9,5	1,1	2,75	Nej	2100	2940	-	500	<b>075 281</b>
		23,0 - 25,0	30,0	9,5	1,1	2,75	Nej	2100	2940	-	250	<b>075 289</b>
6,0	6,1	35,0 - 40,0	45,0	9,5	1,1	2,75	Nej	2100	2940	-	250	<b>075 292</b>
		29,0 - 34,0	40,0	12,0	1,5	3,50	Nej	3000	3900	2500	250	<b>075 309</b>
6,4	6,5	2,0 - 4,0	10,0	13,0	1,8	3,55	Nej	3520	5000	-	250	<b>075 310</b>
		12,0 - 16,0	22,0	13,0	1,8	3,55	Nej	3520	5000	2000	250	<b>075 314</b>
		30,0 - 35,0	40,0	13,0	1,8	3,80	Nej	3120	4100	2500	250	<b>075 318</b>

<sup>1</sup> Minsta kraft vid brott

Tekniska specifikationer är rådgivande och utan garanti! Rätt till ändringar förbehållas.



Stort huvud

**Blindnitkrop**  
Aluminium AlMg 3,5

**Splint**  
Stål förzinkat

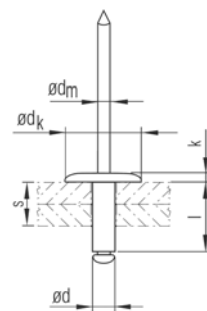

Nominell - ø d [mm]	Borrhål ø [mm]	Klämmområde s [mm]	Blindnit- krop l $+1,0/-0,2$ [mm]	Huvud		Splint		Brottkraft <sup>1</sup> Nominell		Förpackning		Artikelnr.
				ø d <sub>k</sub> ± 0,3 [mm]	Höjd k ≤ [mm]	ø d <sub>m</sub> nom [mm]	Rillad	Skjuvhåll [N]	Drag [N]	Bulk [st]	Box [st]	
3,2	3,3	3,5 - 5,5	8,0	9,5	1,0	1,75	Nej	800	1180	4000	1000	<b>075 501</b>
4,0	4,1	6,5 - 8,5	12,0	12,0	1,2	2,10	Nej	1210	1670	5000	500	<b>075 533</b>
		14,5 - 16,5	20,0	12,0	1,2	2,10	Nej	1210	1670	5000	500	<b>075 535</b>
4,8	5,0	4,5 - 6,0	10,5	13,7	2,5	2,63	Nej	2200	3100	2500	500	<b>075 540<sup>2</sup></b>
		12,5 - 16,0	20,0	14,0	1,3	2,75	Nej	2110	2940	2500	500	<b>075 545</b>
		16,0 - 20,5	25,0	14,0	1,3	2,75	Nej	2110	2940	2000	250	<b>075 546</b>
5,0	5,1	8,5 - 12,0	16,0	14,0	1,3	2,75	Nej	2110	2940	2500	500	<b>075 574</b>
		10,0 - 14,0	18,0	14,0	1,3	2,75	Nej	2110	2940	2500	500	<b>075 575</b>
		12,5 - 16,0	20,0	14,0	1,3	2,75	Nej	2110	2940	2500	500	<b>075 576</b>

<sup>1</sup> Minsta kraft vid brott<sup>2</sup> Med fosfaterad splint

# Standard blindnitar

Extra stort huvud

**Blindnitkrop**  
Aluminium AlMg 3,5

**Splint**  
Stål förzinkat

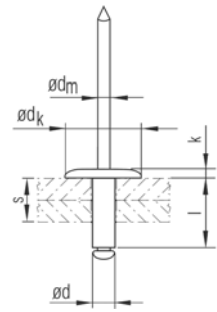

Nominell - $\varnothing$ d [mm]	Borrhål $\varnothing$ [mm]	Klämmområde s [mm]	Blindnit- krop l +1,0/-0,2 [mm]	Huvud		Splint		Brottkraft <sup>1</sup> Nominell		Förpackning		Artikelnr.
				$\varnothing$ $d_k \pm 0,3$ [mm]	Höjd k $\leq$ [mm]	$\varnothing$ $d_m \text{ nom}$ [mm]	Rillad	Skjuvhåll [N]	Drag [N]	Bulk [st]	Box [st]	
4,8	5,0	4,5 - 5,0	10,0	16,0	1,6	2,75	Nej	2110	2940	2500	500	<b>075 550</b>
		8,0 - 10,0	14,0	16,0	1,6	2,75	Nej	2110	2940	2500	500	<b>075 552</b>
		12,5 - 16,0	20,0	16,0	1,6	2,75	Nej	2110	2940	2500	500	<b>075 555</b>

<sup>1</sup> Minsta kraft vid brott

Tekniska specifikationer är rådgivande och utan garanti! Rätt till ändringar förbehållas.

Kullrigt huvud

**Blindnitkrop**  
Stål förzinkat

**Splint**  
Stål förzinkat

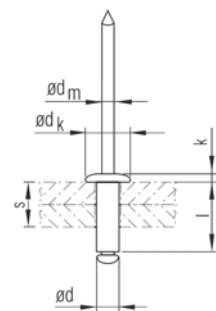

Nominell - $\varnothing$ d [mm]	Borrhål $\varnothing$ [mm]	Klämmområde s [mm]	Blindnit- krop l +1,0/-0,2 [mm]	Huvud		Splint		Brottkraft <sup>1</sup> Nominell		Förpackning		Artikelnr.
				$\varnothing$ d <sub>k</sub> +0,0/-1,0 [mm]	Höjd k ≤ [mm]	$\varnothing$ d <sub>m nom</sub> [mm]	Rillad	Skjuvhåll [N]	Drag [N]	Bulk [st]	Box [st]	
4,0	4,1	2,5 - 4,5	8,0	8,0	1,3	2,35	Nej	1700	2200	10000	1000	<b>076 051</b>
4,8	4,9	8,0 - 10,0	14,0	9,5	1,4	2,90	Nej	2900	3100	5000	500	<b>076 066</b>
		11,0 - 13,0	18,0	9,5	1,4	2,90	Nej	2900	3100	5000	500	<b>076 068</b>
6,4	6,5	7,0 - 10,0	17,0	13,0	2,2	3,80	Nej	4900	5700	2500	250	<b>076 102</b>

<sup>1</sup> Minsta kraft vid brott

Kullrigt huvud

**Blindnitkrop**  
Stål förzinkat

**Splint**  
Stål förzinkat

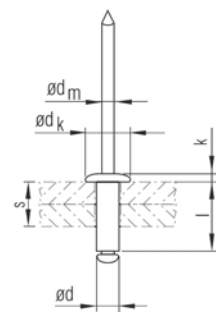

Nominell - $\varnothing$ d [mm]	Borrhål $\varnothing$ [mm]	Klämmområde s [mm]	Blindnit- krop l +1,0/-0,2 [mm]	Huvud		Splint		Brottkraft <sup>1</sup> Nominell		Förpackning		Artikelnr.
				$\varnothing$ d <sub>k</sub> ± 0,3 [mm]	Höjd k ≤ [mm]	$\varnothing$ d <sub>m nom</sub> [mm]	Rillad	Skjuvhåll [N]	Drag [N]	Bulk [st]	Box [st]	
5,0	5,1	4,5 - 6,5	10,0	9,5	1,1	2,75	Nej	3140	4120	4000	500	<b>076 081</b>

<sup>1</sup> Minsta kraft vid brott

# Standard blindnitar

Kullrigt huvud

**Blindnitkrop**  
Rostfritt stål (A2)

**Splint**  
Rostfritt stål (A2)

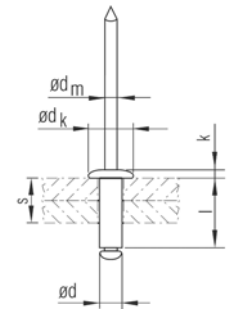

Nominell - $\varnothing$ d [mm]	Borrhål $\varnothing$ [mm]	Klämmområde s [mm]	Blindnit- krop l +1,0/-0,2 [mm]	Huvud		Splint		Brottkraft <sup>1</sup> Nominell		Förpackning		Artikelnr.
				$\varnothing$ $d_k$ +0,0/-0,5 [mm]	Höjd k $\leq$ [mm]	$\varnothing$ $d_m$ nom [mm]	Rillad	Skjuvhåll [N]	Drag [N]	Bulk [st]	Box [st]	
3,2	3,3	1,0 - 3,0	6,0	6,3	1,0	1,75	Ja	1900	2500	10000	1000	<b>076 505</b>
		3,0 - 5,0	8,0	6,3	1,0	1,75	Ja	1900	2500	10000	1000	<b>076 506</b>
		5,0 - 6,5	10,0	6,3	1,0	1,75	Ja	1900	2500	10000	1000	<b>076 507</b>
		6,5 - 8,5	12,0	6,3	1,0	1,75	Ja	1900	2500	10000	1000	<b>076 509</b>
4,0	4,1	2,5 - 4,5	8,0	8,0	1,3	2,45	Ja	3100	3500	10000	500	<b>076 521</b>
		4,5 - 6,5	10,0	8,0	1,3	2,45	Ja	3100	3500	10000	500	<b>076 522</b>
		6,5 - 8,5	12,0	8,0	1,0	2,50	Ja	3100	3800	-	500	<b>076 523</b>
4,8	4,9	6,0 - 8,0	12,0	9,5	1,4	2,85	Ja	4000	5000	5000	500	<b>076 532</b>
		8,0 - 9,5	14,0	9,5	1,4	2,85	Ja	4000	5000	5000	500	<b>076 533</b>
		11,0 - 13,0	18,0	9,5	1,1	2,90	Ja	4500	6000	-	500	<b>076 535</b>

<sup>1</sup> Minsta kraft vid brott

Tekniska specifikationer är rådgivande och utan garanti! Rätt till ändringar förbehållas.

Extra hög  
korrosionsbeständighet

Kullrigt huvud

**Blindnitkrop**  
Rostfritt stål (A4)

**Splint**  
Rostfritt stål (A4)

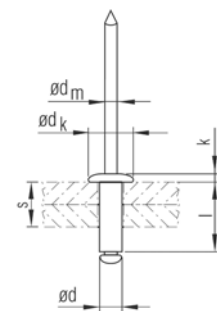

Nominell - ø d [mm]	Borrhål ø [mm]	Klämmområde s [mm]	Blindnit- krop l +1,0/-0,2 [mm]	Huvud		Splint		Brottkraft <sup>1</sup> Nominell		Förpackning		Artikelnr.
				ø d <sub>k</sub> +0,0/-0,5 [mm]	Höjd k ≤ [mm]	ø d <sub>m</sub> nom [mm]	Rillad	Skjuvhåll [N]	Drag [N]	Bulk [st]	Box [st]	
3,0	3,1	0,5 - 3,0	6,0	6,5	0,8	1,75	Ja	1600	2000	10000	1000	<b>076 616</b> <sup>2</sup>
		3,0 - 5,0	8,0	6,5	0,8	1,75	Ja	1600	2000	0000	1000	<b>076 617</b> <sup>2</sup>
		5,0 - 6,5	10,0	6,5	0,8	1,75	Ja	1600	2000	10000	1000	<b>076 618</b> <sup>2</sup>
		6,5 - 8,5	12,0	6,5	0,8	1,75	Ja	1600	2000	10000	1000	<b>076 619</b> <sup>2</sup>
3,2	3,3	0,5 - 3,0	6,0	6,5	0,8	2,00	Ja	1800	2500	10000	1000	<b>076 631</b>
		3,0 - 5,0	8,0	6,5	0,8	2,00	Ja	1800	2500	10000	1000	<b>076 632</b> <sup>2</sup>
		5,0 - 6,5	10,0	6,5	0,8	2,00	Ja	1800	2500	10000	1000	<b>076 633</b>
		6,5 - 8,5	12,0	6,5	0,8	2,00	Ja	1800	2500	10000	1000	<b>076 634</b>
		9,5 - 11,5	15,0	6,5	0,8	2,00	Ja	1800	2500	10000	1000	<b>076 636</b> <sup>2</sup>
4,0	4,1	1,0 - 2,5	6,0	8,0	1,0	2,50	Ja	3100	3800	10000	1000	<b>076 646</b> <sup>2</sup>
		2,5 - 4,5	8,0	8,0	1,0	2,50	Ja	3100	3800	10000	1000	<b>076 647</b>
		4,5 - 6,5	10,0	8,0	1,0	2,50	Ja	3100	3800	10000	1000	<b>076 648</b> <sup>2</sup>
		6,5 - 8,5	12,0	8,0	1,0	2,50	Ja	3100	3800	10000	1000	<b>076 649</b>
		8,5 - 10,0	14,0	8,0	1,0	2,50	Ja	3100	3800	5000	500	<b>076 650</b> <sup>2</sup>
		10,0 - 12,0	16,0	8,0	1,0	2,50	Ja	3100	3800	5000	500	<b>076 651</b>
		12,0 - 14,0	18,0	8,0	1,0	2,50	Ja	3100	3800	5000	500	<b>076 652</b> <sup>2</sup>
		14,0 - 16,0	20,0	8,0	1,0	2,50	Ja	3100	3800	5000	500	<b>076 653</b> <sup>2</sup>
4,8	4,9	2,0 - 4,0	8,0	9,5	1,1	2,90	Ja	4500	6000	5000	500	<b>076 662</b>
		4,0 - 6,0	10,0	9,5	1,1	2,90	Ja	4500	6000	5000	500	<b>076 663</b>
		6,0 - 8,0	12,0	9,5	1,1	2,90	Ja	4500	6000	5000	500	<b>076 664</b>
		8,0 - 10,0	14,0	9,5	1,1	2,90	Ja	4500	6000	5000	500	<b>076 665</b> <sup>2</sup>
		9,0 - 11,0	16,0	9,5	1,1	2,90	Ja	4500	6000	5000	500	<b>076 666</b>
		11,0 - 13,0	18,0	9,5	1,1	2,90	Ja	4500	6000	5000	500	<b>076 667</b> <sup>2</sup>
		13,0 - 15,0	20,0	9,5	1,1	2,90	Ja	4500	6000	5000	500	<b>076 668</b>
5,0	5,1	2,0 - 4,0	8,0	9,5	1,4	2,85	Ja	4700	5800	5000	500	<b>076 677</b> <sup>2</sup>
		4,0 - 6,0	10,0	9,5	1,4	2,85	Ja	4700	5800	5000	500	<b>076 678</b> <sup>2</sup>
		6,0 - 8,0	12,0	9,5	1,4	2,85	Ja	4700	5800	5000	500	<b>076 679</b> <sup>2</sup>
		9,0 - 11,0	16,0	9,5	1,4	2,85	Ja	4700	5800	5000	500	<b>076 681</b> <sup>2</sup>
6,0	6,1	1,0 - 2,5	8,0	12,0	2,0	3,65	Ja	6500	8830	2500	250	<b>076 692</b> <sup>2</sup>
		4,5 - 6,0	12,0	12,0	2,0	3,65	Ja	6500	8830	2500	250	<b>076 694</b> <sup>2</sup>
		7,0 - 9,0	15,0	12,0	2,0	3,65	Ja	6500	8830	2500	250	<b>076 696</b> <sup>2</sup>
		10,0 - 12,0	18,0	12,0	2,0	3,65	Ja	6500	8830	2500	250	<b>076 698</b> <sup>2</sup>
		12,0 - 14,0	20,0	12,0	2,0	3,65	Ja	6500	8830	2500	250	<b>076 699</b> <sup>2</sup>
6,4	6,5	4,5 - 6,0	12,0	13,0	2,2	3,85	Ja	7500	9300	2500	250	<b>076 709</b> <sup>2</sup>
		7,0 - 9,0	15,0	13,0	2,2	3,85	Ja	7500	9300	2500	250	<b>076 711</b>
		10,0 - 12,0	18,0	13,0	2,2	3,85	Ja	7500	9300	2500	250	<b>076 713</b>
		12,0 - 14,0	20,0	13,0	2,2	3,85	Ja	7500	9300	2500	250	<b>076 714</b> <sup>2</sup>
		14,0 - 18,0	25,0	13,0	2,2	3,85	Ja	7500	9300	2500	250	<b>076 716</b> <sup>2</sup>

<sup>1</sup> Minsta kraft vid brott<sup>2</sup> Inte i lager vid katalog publicering. Kolla [www.titgemeyer.se](http://www.titgemeyer.se) om uppdaterad katalog!

Tekniska specifikationer är rådgivande och utan garanti! Rätt till ändringar förbehållas.

# Standard blindnitar, färgad

Kullrigt huvud

**Blindnitkrop**  
Aluminium AlMg 2,5

**Splint**  
Stål förzinkat

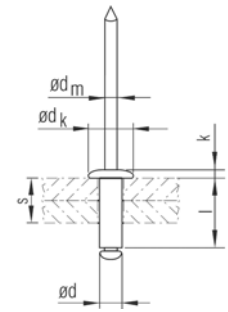

Nominell - ø d [mm]	Borrhål ø [mm]	Klämmområde s [mm]	Blindnit- krop l +1,08/-0,2 [mm]	Huvud		Splint		Brottkraft <sup>1</sup> Nominell		Förpackning		Artikelnr.
				ø d <sub>k</sub> +0,0/-0,5 [mm]	Höjd k ≤ [mm]	ø d <sub>m nom</sub> [mm]	Rillad	Skjuvhåll [N]	Drag [N]	Bulk [st]	Box [st]	
3,2	3,3	3,5 - 5,0	8,0	6,3	1,0	1,75	Nej	760	980	10000	1000	075 320 Vit 075 340 Svart
		3,5 - 5,0	8,0	6,3	1,0	1,75	Nej	760	980	10000	1000	

<sup>1</sup> Minsta kraft vid brott

Tekniska specifikationer är rådgivande och utan garanti! Rätt till ändringar förbehållas.

Kullrigt huvud

**Blindnitkrop**  
Aluminium AlMg 3,5

**Splint**  
Stål förzinkat

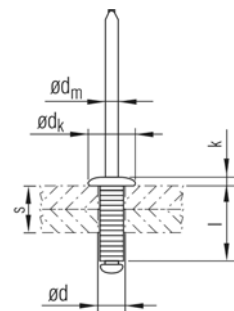

Nominell - $\varnothing$ d [mm]	Borrhål $\varnothing$ [mm]	Klämmområde s [mm]	Blindnit- krop l +1,0/-0,2 [mm]	Huvud		Splint		Brottkraft <sup>1</sup> Nominell		Förpackning		Artikelnr.
				$\varnothing$ $d_k \pm 0,3$ [mm]	Höjd k $\leq$ [mm]	$\varnothing$ $d_m \text{ nom}$ [mm]	Rillad	Skjuvhåll [N]	Drag [N]	Bulk [st]	Box [st]	
5,0	5,1	Max 3,0	7,5	9,5	1,1	2,75	Nej	1850	2810	5000	500	075 600
		Max 6,0	11,0	9,5	1,1	2,75	Nej	1850	2810	5000	500	075 601
		Max 10,0	14,5	9,5	1,1	2,75	Nej	1850	2810	4000	500	075 602

<sup>1</sup> Minsta kraft vid brott

# Split blindnitar

Kullrigt huvud

**Blindnitkrop**  
Aluminium AlMg 5,0

**Splint**  
Stål förzinkat

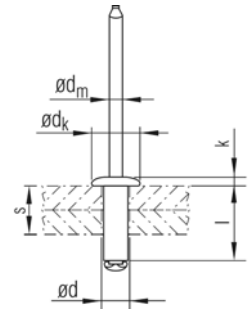

Nominell - $\varnothing$ d [mm]	Borrhål $\varnothing$ [mm]	Klämmområde s [mm]	Blindnit- krop l +1,0/-0,2 [mm]	Huvud		Splint		Brottkraft <sup>1</sup> Nominell		Förpackning		Artikelnr.
				$\varnothing$ d <sub>k</sub> +0,0/-0,5 [mm]	Höjd k ≤ [mm]	$\varnothing$ d <sub>m nom</sub> [mm]	Rillad	Skjuvhåll [N]	Drag [N]	Bulk [st]	Box [st]	
3,0	Max 3,4	- 1,0	6,5	6,3	1,0	1,70	Nej	650	550	10000	1000	<b>075 607</b>
3,2	Max 3,7	- 1,0	6,5	6,3	1,0	1,92	Nej	760	620	20000	1000	<b>075 608</b>
		0,5 - 1,0	8,0	6,3	1,0	1,92	Nej	760	620	10000	1000	<b>075 609</b>
		1,0 - 3,0	10,0	6,3	1,0	1,92	Nej	760	620	10000	1000	<b>075 610</b>
		3,0 - 5,0	12,0	6,3	1,0	1,92	Nej	760	620	10000	1000	<b>075 611</b>
4,8	Max 5,3	4,0 - 8,0	14,0	9,5	1,4	2,80	Nej	1690	1600	5000	500	<b>075 633</b>
		8,0 - 12,0	18,0	9,5	1,4	2,80	Nej	1690	1600	5000	500	<b>075 635</b>

<sup>1</sup> Minsta kraft vid brott

Tekniska specifikationer är rådgivande och utan garanti! Rätt till ändringar förbehållas.



## ■ TRYCKTÄTA BLINDNITAR

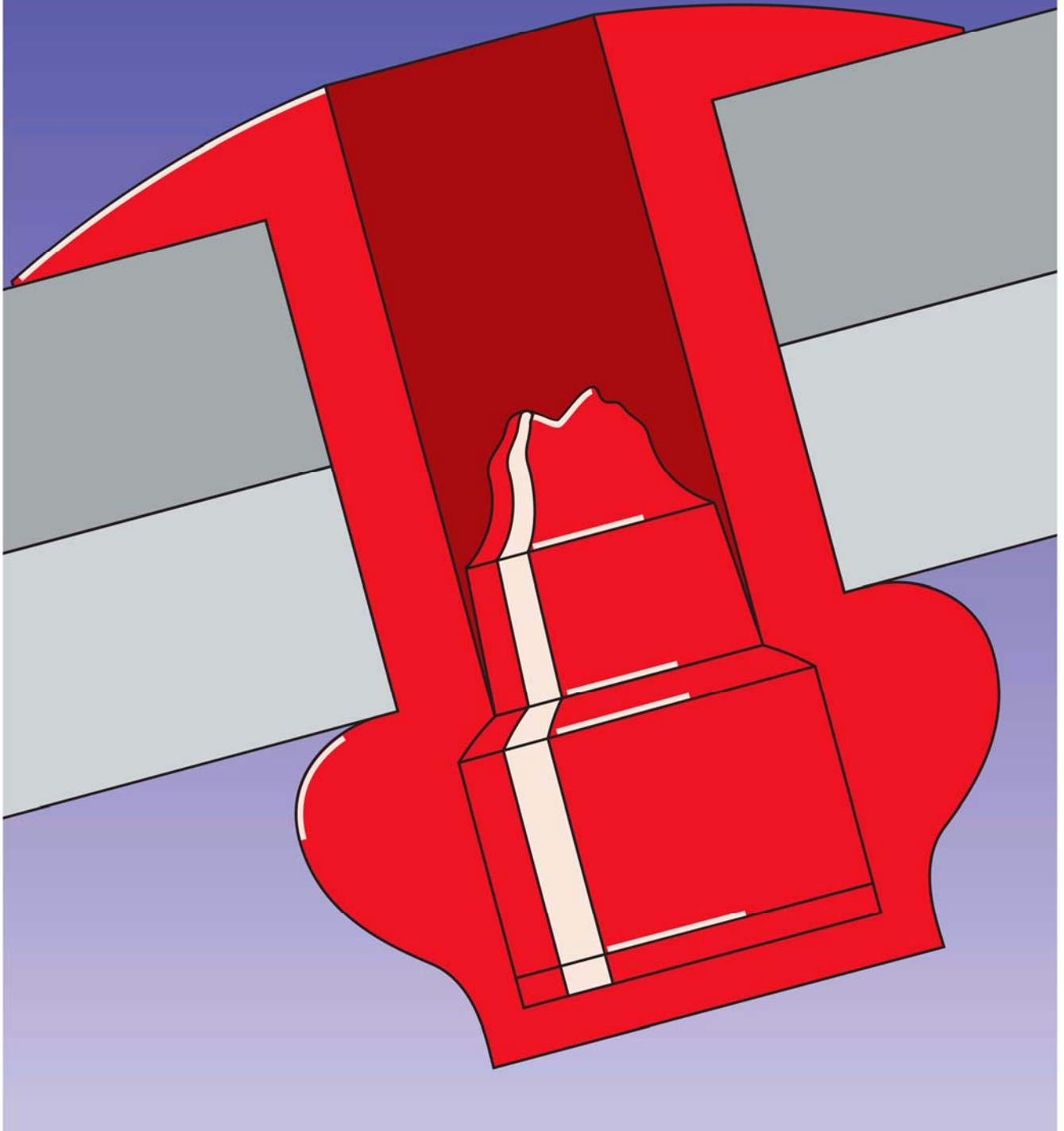

# Trycktäta blindnitar

Kullrigt huvud

**Blindnitkrop**  
Aluminium AlMg5

**Splint**  
Kolstål

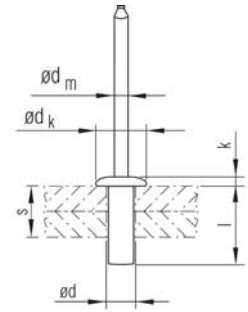

Nominell - ø d [mm]	Borrhål ø [mm]	Klämmområde s [mm]	Blindnit- krop l +1,0/-0,2 [mm]	Huvud		Splint		Brottkraft <sup>1</sup> Nominell		Förpackning		Artikelnr.
				ø d <sub>k</sub> ± 0,9 [mm]	Höjd k ≤ [mm]	ø d <sub>m</sub> nom [mm]	Rillad	Skjuvhåll [N]	Drag [N]	Bulk [st]	Box [st]	
4,8	5,0	2,0 - 3,5	8,0	9,6	2,0	2,63	Nej	2200	3100	10000	500	<b>075 740</b>
		4,0 - 5,5	9,5	9,6	2,0	2,63	Nej	2200	3100	10000	500	<b>075 741</b>
		5,5 - 7,0	11,5	9,6	2,0	2,63	Nej	2200	3100	10000	500	<b>075 742</b>
		7,0 - 8,5	13,0	9,6	2,0	2,63	Nej	2200	3100	5000	500	<b>075 743</b>
		8,0 - 9,5	14,5	9,6	2,0	2,63	Nej	2200	3100	5000	500	<b>075 744</b>
		11,0 - 13,0	18,0	9,6	2,0	2,63	Nej	2200	3100	5000	500	<b>075 745</b>
6,4	6,6	2,0 - 7,0	13,0	12,7	2,5	3,65	Nej	3600	4900	2500	250	<b>075 753</b>
		5,0 - 10,0	16,0	12,7	2,5	3,65	Nej	3600	4900	2500	250	<b>075 755</b>

<sup>1</sup> Minsta kraft vid brott

Tekniska specifikationer är rådgivande och utan garanti! Rätt till ändringar förbehållas.

Stort huvud

**Blindnitkrop**  
Aluminium AlMg5

**Splint**  
Kolstål

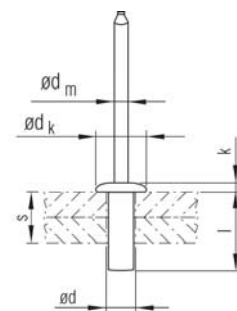

Nominell - $\varnothing$ d [mm]	Borrhål $\varnothing$ [mm]	Klämmområde s [mm]	Blindnit- krop l +1,0/-0,2 [mm]	Huvud		Splint		Brottkraft <sup>1</sup> Nominell		Förpackning		Artikelnr.
				$\varnothing$ $d_k \pm 0,9$ [mm]	Höjd k $\leq$ [mm]	$\varnothing$ $d_m \text{ nom}$ [mm]	Rillad	Skjuvhåll [N]	Drag [N]	Bulk [st]	Box [st]	
4,8	4,9 - 5,0	4,0 - 5,5	10,5	9,83	2,05	2,63	Nej	2260	3110	5000	500	<b>075 803</b>

<sup>1</sup> Minsta kraft vid brott

 **TITGEMEYER Sverige**  
Box 3218  
530 03 Jönköping  
Sverige  
Telefon: +46 (0)36 128350  
eMail: [info@titgemeyer.se](mailto:info@titgemeyer.se)

[www.titgemeyer.se](http://www.titgemeyer.se)